

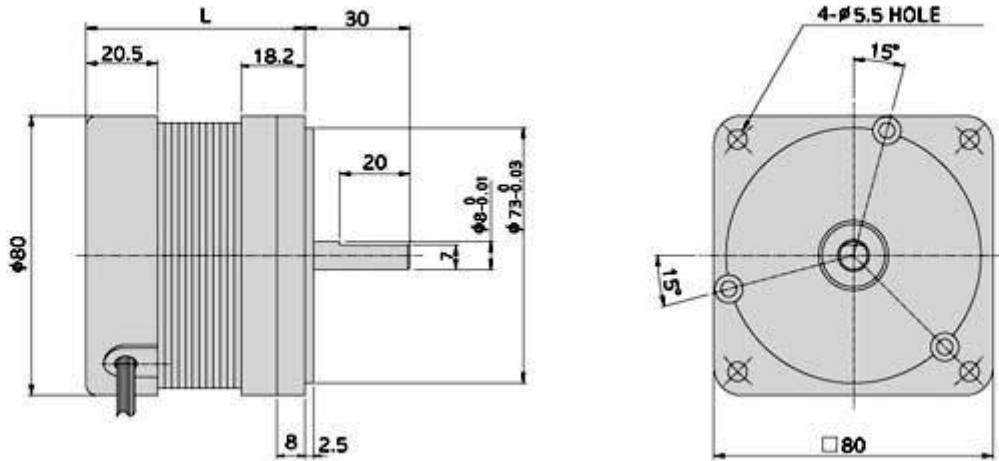

OUTPUT	MODEL	TYPE
40W BLDC24V 3000RPM (□ 80mm)	BD80-N024040	BD80 씨리즈 (동근축 BLDC 모터)

DIMENSIONS



SPECIFICATIONS

▶ □ 80

MODEL		BD80-								
		N012025	N012040	N012060	N024040	N024060	N024080	N220060	N220080	N220100
Rated Voltage	V	12			24			220		
Rated Output	W	25	40	60	40	60	80	60	80	100
Rated Current	A	2.6	4.2	6.3	2	3	4.2	0.5	0.6	0.8
Rated Speed	r/min	3000								
Rated Torque	kgf-cm	0.8	1.3	1.9	1.3	1.9	2.5	1.9	2.5	3.2
Weight	kg	1.4	1.5	1.6	1.4	1.5	1.6	1.4	1.5	1.6
Pole	P	12	12	12	12	12	12	12	12	12
Length	L (mm)	52.7	62.7	72.7	52.7	62.7	72.7	52.7	62.7	72.7

* SHAFT 형상 (D: 동근축 D-CUT, G: 일반 기어축)



DOWNLOAD		
DIMENSION	CAD	3D
CATALOGUE	PDF	

MODEL	적용제품	특성
K8B (□80mm)	표준형 모터 □80mm GEARHEAD : K8G□C(B)	중량 120g 재질 AL

DIMENSIONS

