

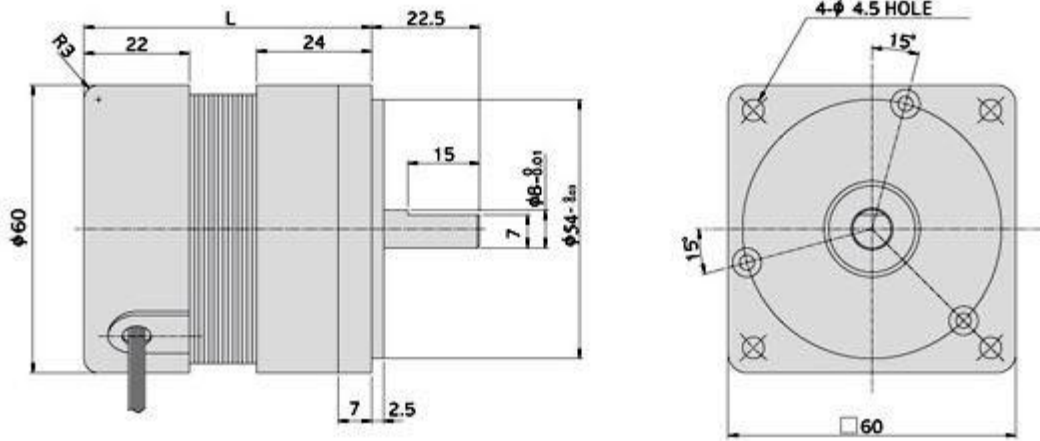

OUTPUT	MODEL	TYPE
50W BLDC24V 3000RPM (□ 60mm)	BD60-N024050	BD60 시리즈 (동근축 BLDC 모터)

DIMENSIONS

Dimensions(UNIT:mm)



SPECIFICATIONS

▶ □ 60 BLDC

MODEL		BD60-								
		N012010	N012015	N012020	N024020	N024040	N024050	N220040	N220060	N220080
Rated Voltage	V	12			24			220		
Rated Output	W	10	15	20	20	40	50	40	60	80
Rated Current	A	1.4	2	2.8	1.4	2.8	3.5	0.7	0.9	1.2
Rated Speed	r/min	3000								
Rated Torque	kgf-cm	0.3	0.4	0.6	0.6	1.3	1.6	1.3	1.9	2.5
Weight	kg	0.5	0.6	0.7	0.5	0.6	0.7	0.5	0.6	0.7
Pole	P	4	4	4	4	4	4	4	4	4
Length	L (mm)	60	70	80	60	70	80	60	70	80

※ SHAFT 형상 (D: 동근축 D-CUT, G: 일반 기어축)



DOWNLOAD

DIMENSION	CAD	3D
	PDF	

MODEL	적용제품	특성
K6B (□60mm)	표준형 모터 □60mm GEARHEAD : K6G□C(B)	중량 45g 재질 AL

DIMENSIONS

