

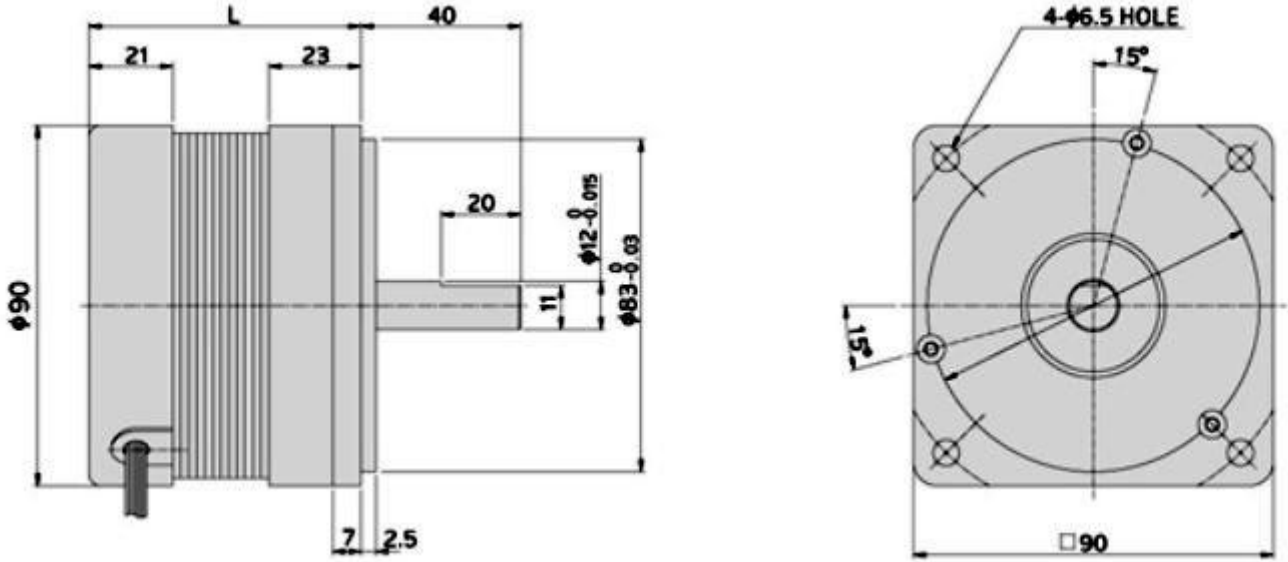

OUTPUT	MODEL	TYPE
200W BLDC220V 3000RPM (□ 90mm)	BD90-N220200	BD90 시리즈 (동근축 BLDC 모터)

DIMENSIONS



SPECIFICATIONS

▶ □ 90

MODEL		BD90								
		N012040	N012060	N012070	N024060	N024100	N024150	N220100	N220150	N220200
Rated Voltage	V	12			24			220		
Rated Output	W	40	60	70	60	100	150	100	150	200
Rated Current	A	5.4	8.1	9.7	3.5	6.7	10.1	0.8	1.1	1.5
Rated Speed	r/min	3000								
Rated Torque	kgf-cm	1.3	1.9	2.2	1.9	3.2	4.8	3.2	4.8	6.3
Weight	kg	2.1	2.3	2.5	2.1	2.3	2.5	2.1	2.3	2.5
Pole	P	12	12	12	12	12	12	12	12	12
Length	L (mm)	57.5	67.5	77.5	57.5	67.5	77.5	57.5	67.5	77.5

※ SHAFT 형상 (D: 동근축 D-CUT, G: 기어축)



DOWNLOAD		
DIMENSION	CAD	3D
CATALOGUE	PDF	

MODEL	적용제품	특성
K9B-M6 (□90mm)	표준형 모터 □90mm GEARHEAD : K9G□C, K9P□B	중량 270g 재질 AL

DIMENSIONS

